

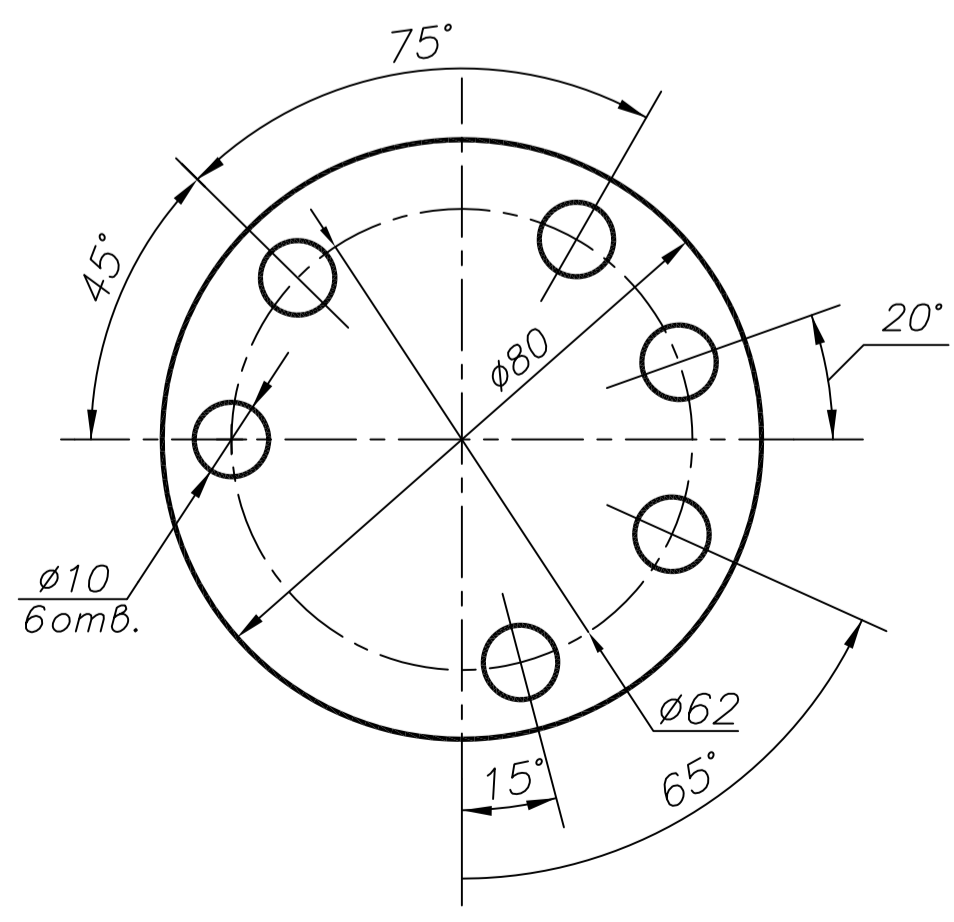

Нанесение размеров на чертежах по ГОСТ 2.307-68

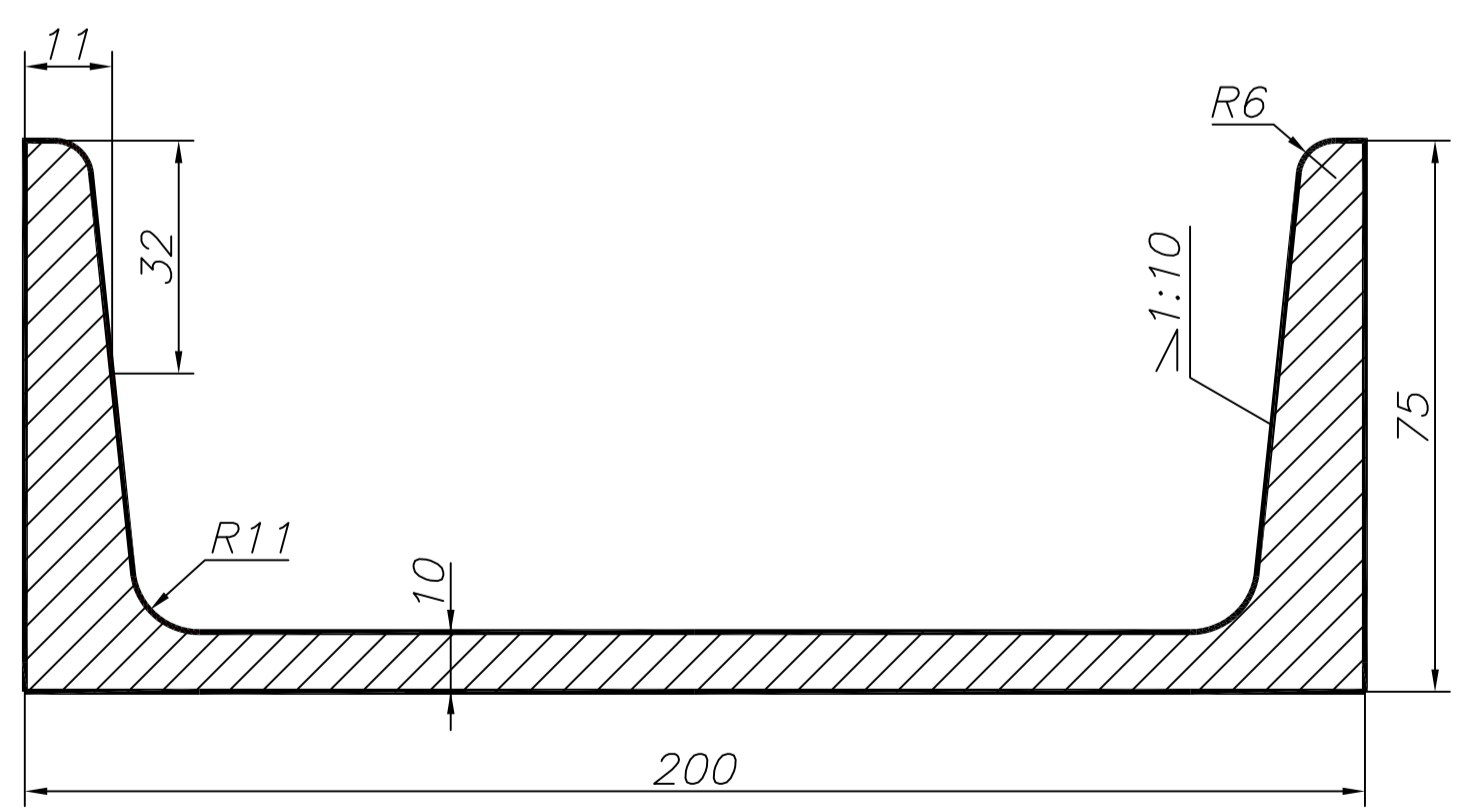
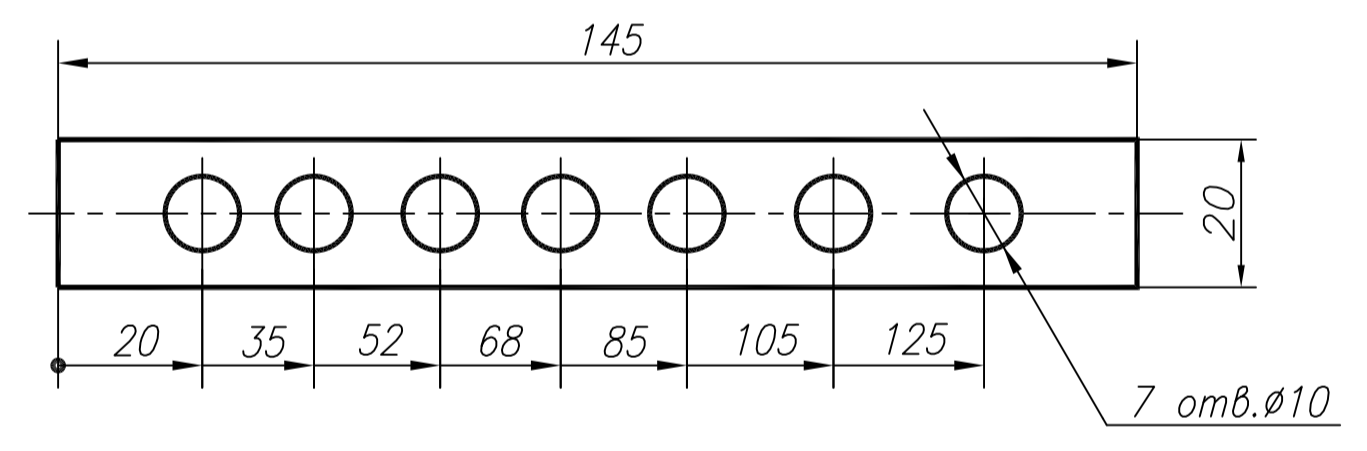
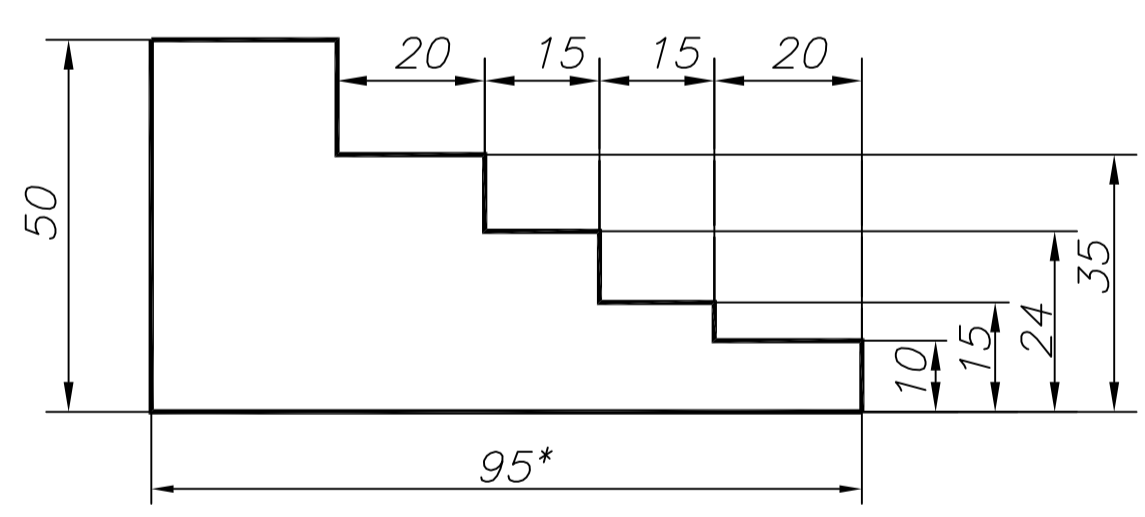
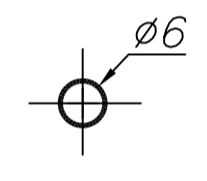
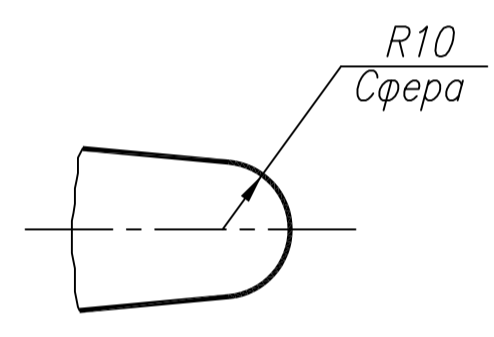
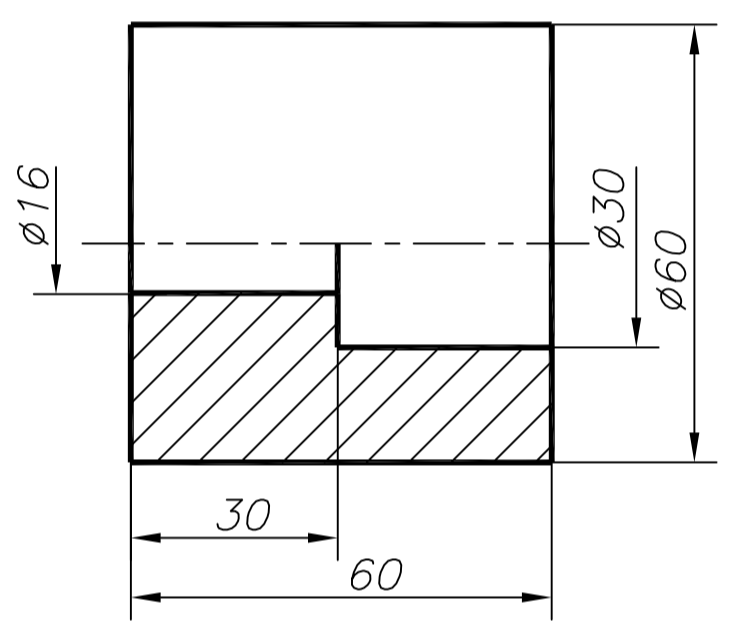
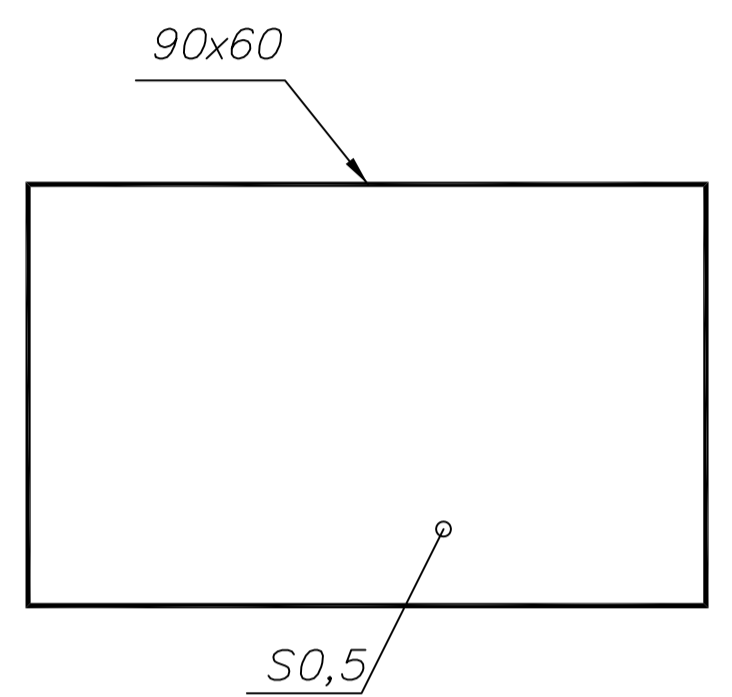
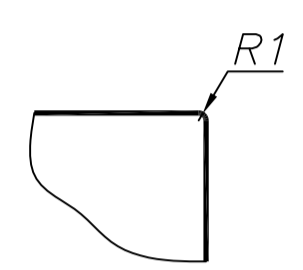
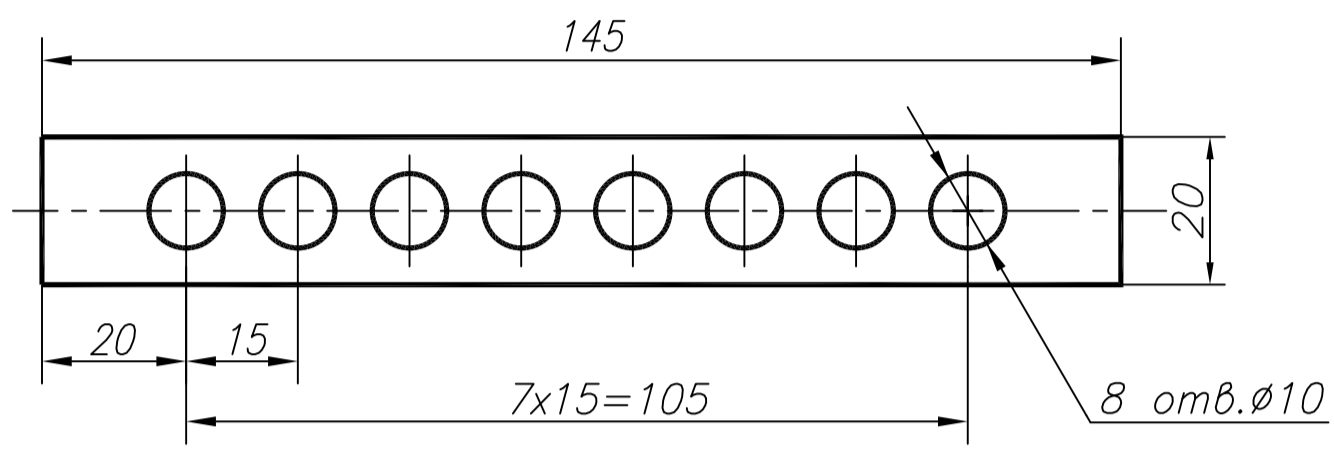
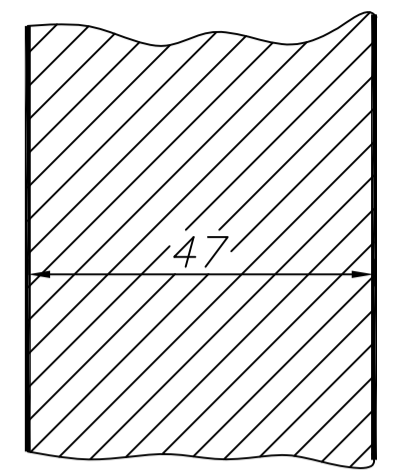
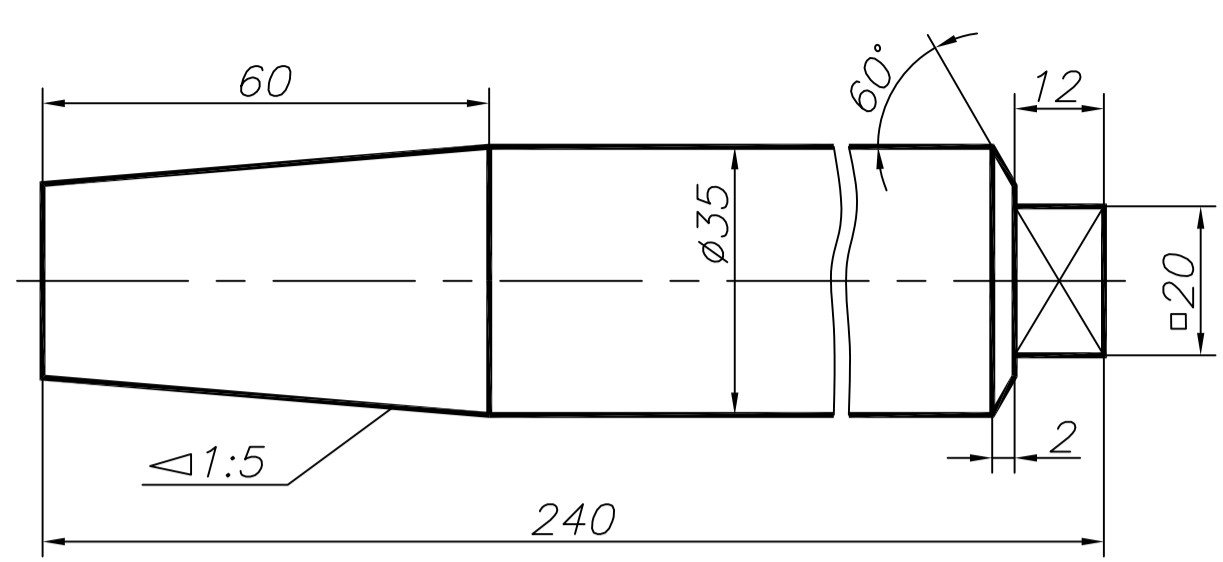
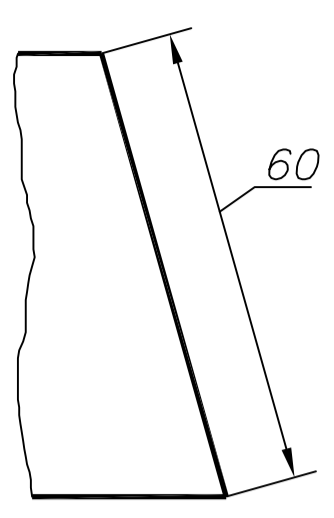

* Размер для справок

Вариант 6

Изм.	Лист	Документа	Подпись	Дата	Литера	Масса	Масштаб
Разработал							
Проверил							
Т.Контроль					Лист	Листов	
Н.Контроль					МГУЛ		
Утверд.							